

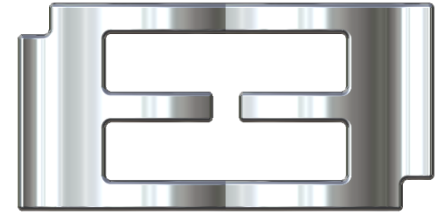

# CRITICAL INFRASTRUCTURE MODULES



## 1 x 750 kVA UPS Module Data Sheet

### BENEFITS

- High Degree of Redundancy
- Efficient
- High-Quality
- Raised Floors
- Modular
- Scalable
- JIT Manufacturing
- Sound Investment
- Rapid Deployment
- Cost Effective
- Long Life
- Great ROI
- Customizable
- Vendor Neutral
- Supply Chain Management
- Purpose Built
- Industry Standard Components
- Designed for Low Cost Transport and Installation
- LEED, UL, IECC and other certifications available

Contact Us:  
Info@e3nv.com  
775-204-0300



CRITICAL  
INFRASTRUCTURE  
MODULES

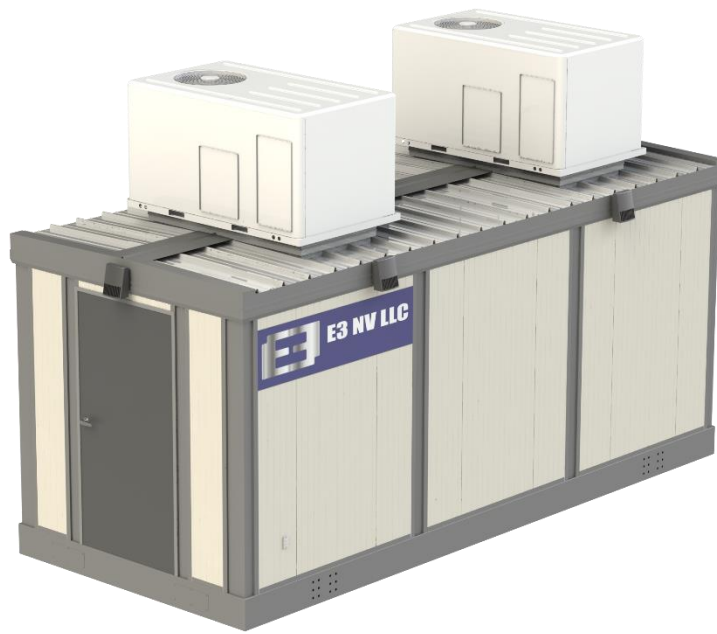

| Standard Features:                                | Optional Features                  |
|---|------------------------------------|
| 1 x 750 kVA Toshiba UPS                           | N+1, N+2, 2N For Any Component     |
| Square D Transformers                             | Awnings                            |
| Square D 180 volt Mechanical Panel                | Vestibules                         |
| Square D Static Switches                          | Landings/Stairs/Ramps              |
| GE Breaker Panels                                 | Heating                            |
| AAON HVAC   | Climate Control                    |
| RFI Computer Room Raised Flooring                 | FM 200 Fire Suppression            |
| IECC, IEGC, UL Compliance                         | High-Strand/Super Flex Copper Wire |
| 12ft Wide, 38ft Long, 10ft 5in Height             | Overhead Cable Trays               |
| Inexpensive to Transport; Little to No Permitting | Stationary or Mobile Units         |
| Fully Insulated: R30 Walls and Roof               | Water/Leak Detection               |
| Cool Roof Compliance (energy savings)             | Radiation Shielding*               |
| LED Lighting                                      | EMP Hardening*                     |
| Under Floor Ladder Rack                           | Ballistics Approved Panels*        |
| Built to Miami Dade Wind & Uplift Code            | Stackable Units                    |
| Fire Rated Doors                                  | Custom Configuration               |

Specifications are subject to change without notice. Component availability and lead times may vary.

**Purchase Price: \$618,750**

Standard Unit Base Price

For volume or wholesale pricing please contact us.

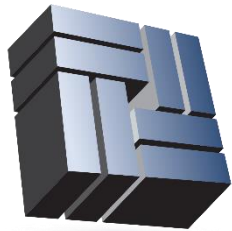

**CRITICAL**  
**INFRASTRUCTURE**  
**MODULES**

1 x 750 kVA Modular UPS Unit

Contact Us:

[Info@e3nv.com](mailto:Info@e3nv.com)

775-204-0300



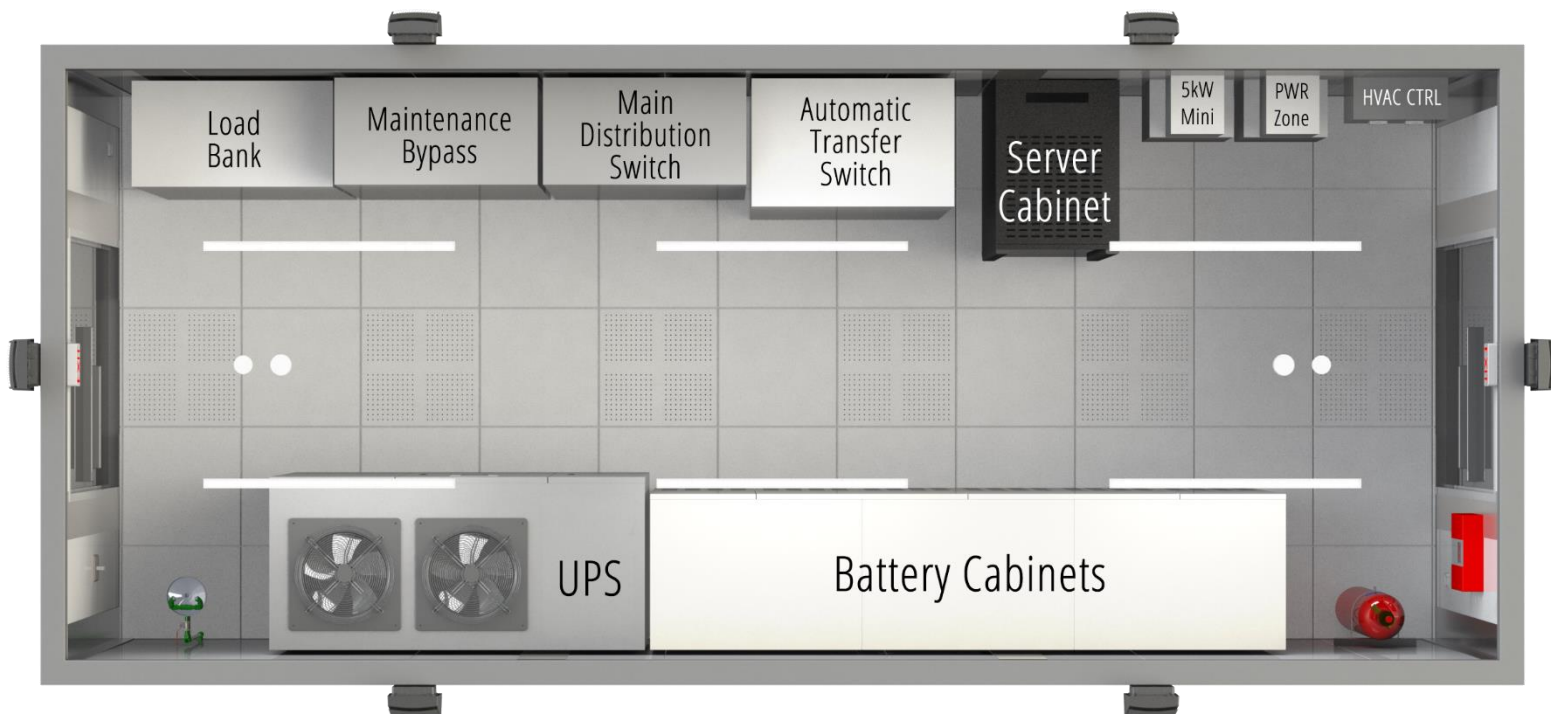

Noted above is a floor plan for a single UPS CIM from a top-down perspective with equipment labeled.

Below is a cut-away of a 750 kVA unit.

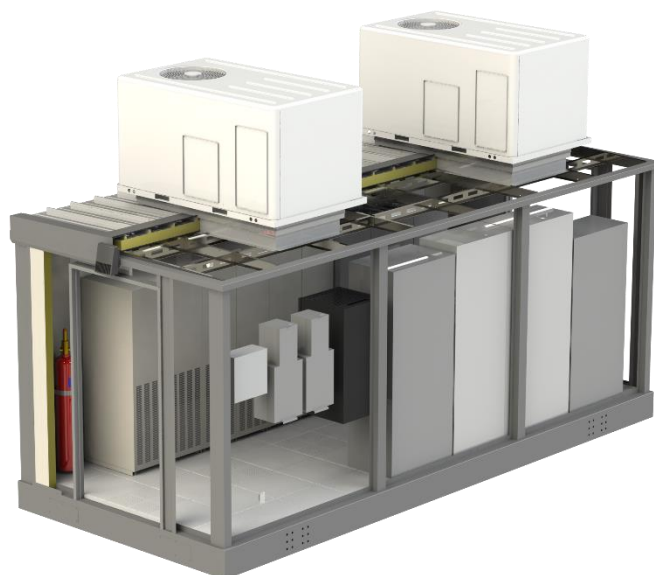

### Contact Us:

1-775-246-8111

E3 NV, LLC

[info@e3nv.com](mailto:info@e3nv.com)

Modules can be configured side-by-side, end-to-end or stacked. Stacked units will require a custom configuration. The cut away above has several optional features selected such as the FM 200 fire suppression system. Air conditioners do not have to be rooftop units. Please contact us for customization options.



HVAC SYSTEM NOT SHOWN

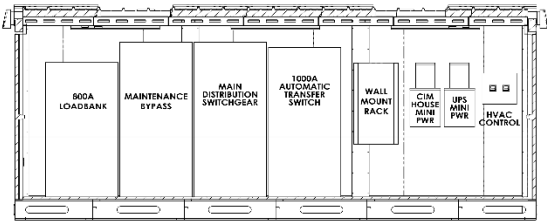

SECTION A-A

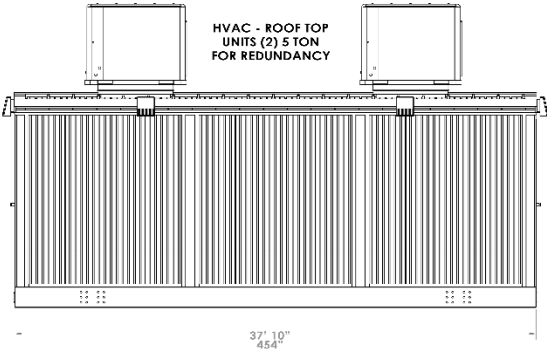

ELEVATION VIEW

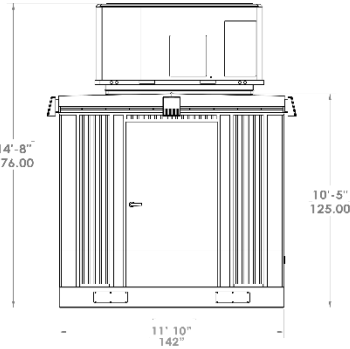

ELEVATION VIEW

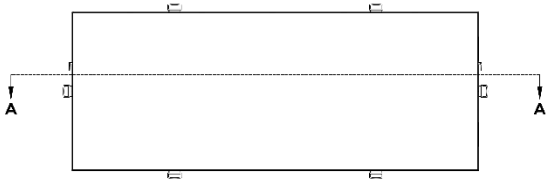
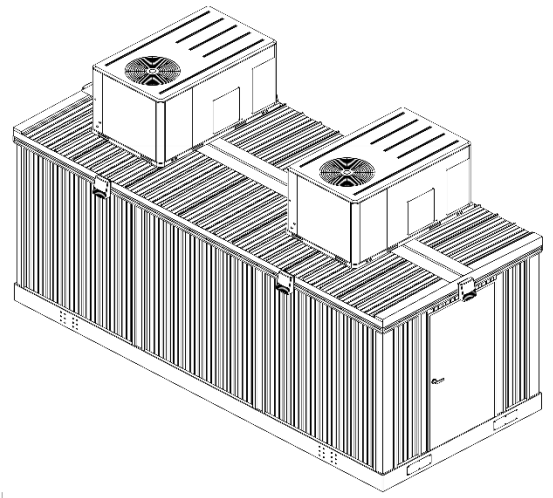

Our Partners:

